

University of Nevada, Las Vegas Las Vegas Computer Science 477/677 Fall 2019
Assignment 4: Due Wednesday October 2, 2019

Name:

You are permitted to work in groups, get help from others, read books, and use the internet. But the handwriting on this document must be your own. Print out the document, staple, and fill in the answers. You may attach extra sheets, but only by stapling. Turn in the pages to the graduate assistant at the beginning of class, September 11.

1. Work Problem 3.1 on page 95 of your textbook.

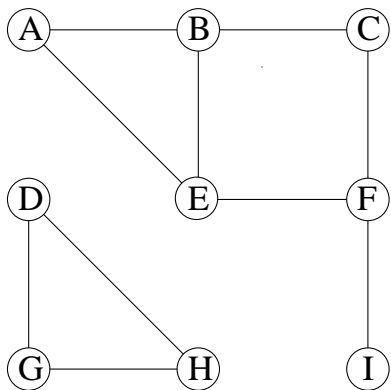

2. Work Problem 3.2 on page 95 of your textbook.

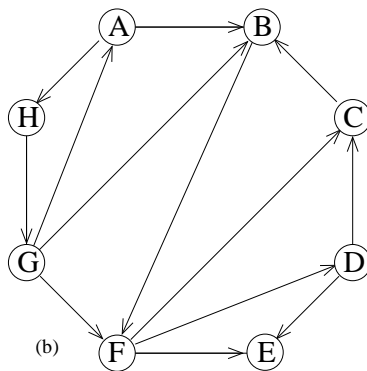
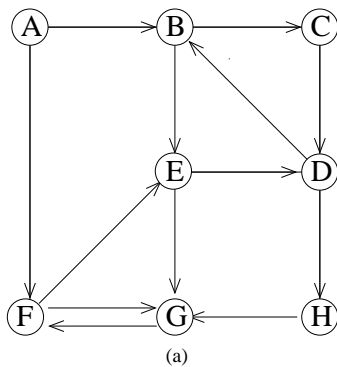

3. Work Problem 3.3 on page 95 of your textbook.

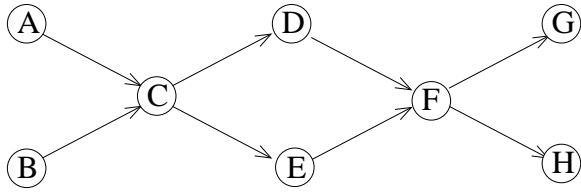

4. Work Problem 3.4 on page 96 of your textbook.

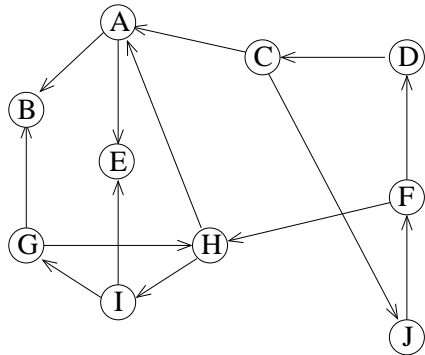

(i)

G^R

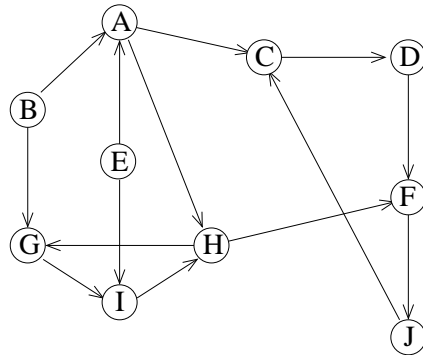

G

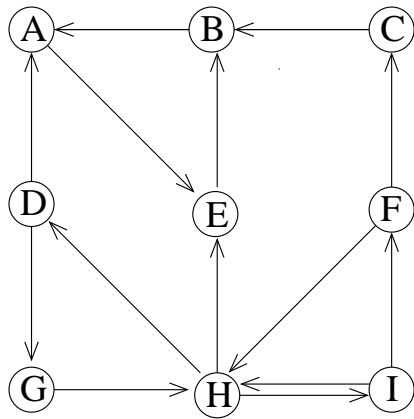

(ii)

G^R

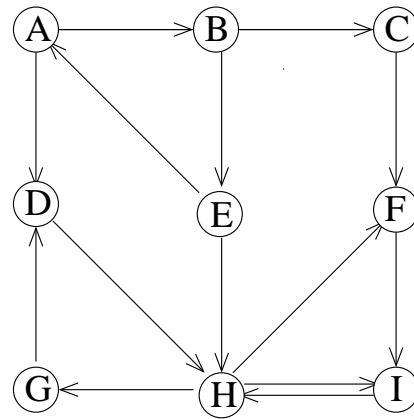

G

5. Work Problem 3.6(a) on page 96–97 of your textbook. Assume the graph G is given to you in adjacency list format.